



MODULATE CURVO

MOD-C

Modulate™ è costituito da una serie di cornici con tubolari in alluminio (Ø 30 mm) e rivestiti da una stampa in tessuto elasticizzato.

Queste strutture possono facilmente connettersi tra loro usando potenti magneti posizionati all'interno di ogni struttura. La gamma Modulate™ è disponibile in 19 diversi formati.

CARATTERISTICHE

Struttura tubolare in alluminio (Ø 30 mm)

Sistema autobloccante con tubolari a sezioni e pulsante a scatto

Rivestimento con una stampa in tessuto fronte-retro con chiusura a zip

Sistema di etichettatura numerata intuitiva di ogni sezione per facilitare l'assemblaggio

2 basi di supporto con sistema Twist & Lock fornite con ogni cornice

I PLUS

Grazie al sistema magnetico MagLink integrato nella struttura, le cornici possono essere collegate tra loro semplicemente avvicinandole

Le stampe in tessuto richiedono poca manutenzione essendo ingualcibili e lavabili in lavatrice



Tubo di rinforzo centrale (Ø 18 mm)

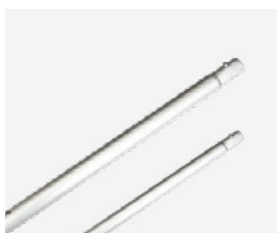

Estensione da 400mm opzionale



Borsa per il trasporto

SCHEDA PRODOTTO

SPECIFICHE TECNICHE

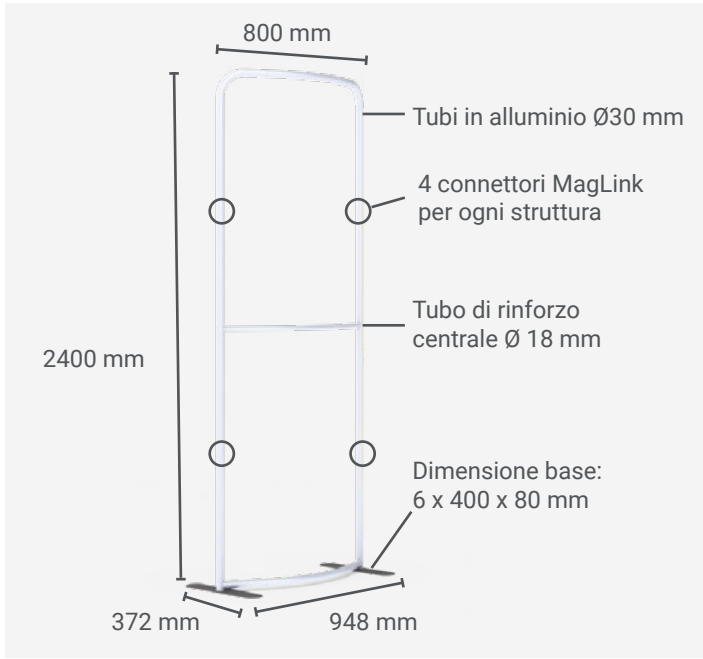

Codice	Descrizione	Dimensioni struttura (mm) - h x l x p	Area grafica (mm) - h x l	Peso struttura
MOD-C-820	Modulate Curvo 820	2000 x 948 x 372	1982 x 895	6.45 kg

MOD-C-824-PH	Modulate Curvo 824	2400 x 948 x 372	2382 x 895	6.93 kg
--------------	--------------------	------------------	------------	---------

Codice	Descrizione	Dimensione imballo (mm) - h x l x p	Peso imballo
MOD-C-820	Modulate Curvo 820	245 x 1000 x 125	6.80 kg

MOD-C-824-PH	Modulate Curvo 824	245 x 1000 x 125 + 65 x 460 x 65	7.27 kg (2 scatole)
--------------	--------------------	----------------------------------	---------------------

SCHEDA PRODOTTO

ASSEMBLAGGIO STRUTTURA

1 COMPONENTI

Sezioni tubolari superiori

Tubo orizzontale superiore

Tubo orizzontale inferiore

Sezioni tubolari verticali

Tubo di rinforzo centrale

Kit di estensione

Basi

Guanti

2 Utilizza il sistema di etichettatura numerata

Premi il pulsante a scatto per unire le sezioni tubolari

3 Infilare la grafica

Chiudi la zip

4 Infilare la ruota

Ruota

5 L'adesivo sulla base mostra le indicazioni di bloccaggio e sbloccaggio della base stessa

Due posizioni per le basi: all'interno o all'esterno della struttura

ISTRUZIONI MONTAGGIO

ASSEMBLAGGIO ESTENSIONI

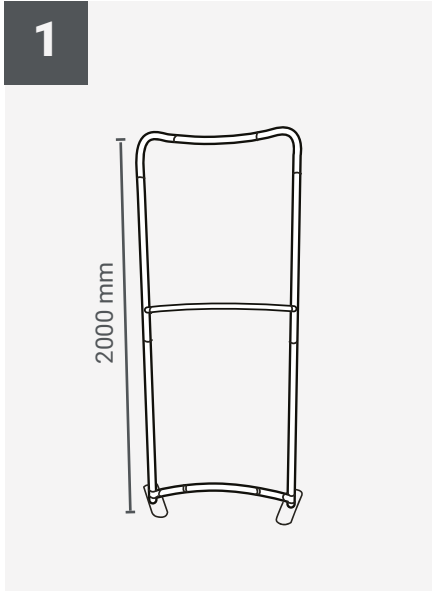

UNIRE PIÙ CORNICI

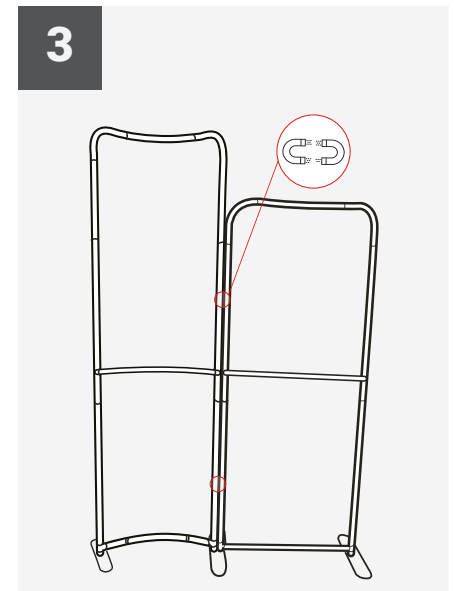
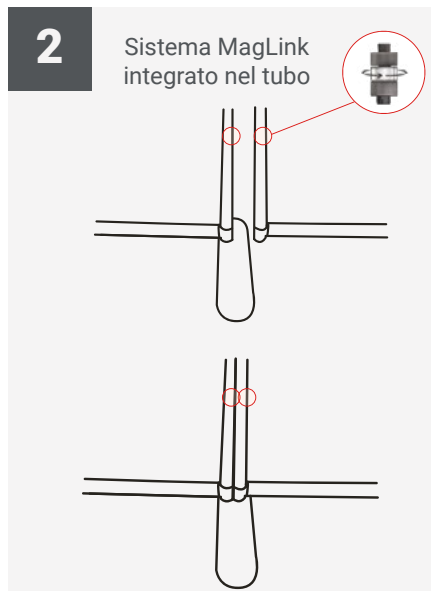
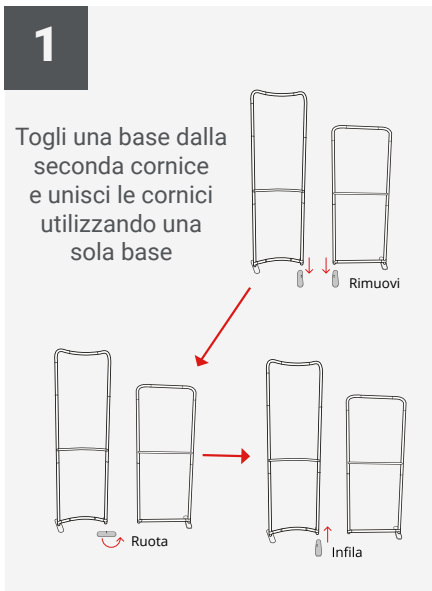

ISTRUZIONI MONTAGGIO

ACCESSORI (SU RICHIESTA)



Mezze basi Modulate (a coppia)
MOD-HALF-FOOT-P
6 x 218 x 80 mm



Spot LED Flood
LED-FLOOD-ARM-BDLK



Kit di fissaggio universale
US901-C

MIX & MATCH: LA LINEA MODULATE

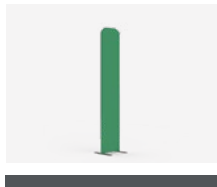

Straight 420
MOD-S-420

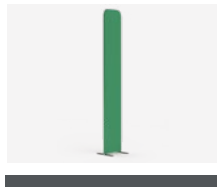

Straight 424
MOD-S-424

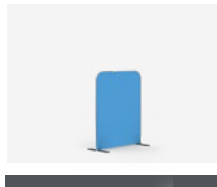

Straight 810
MOD-S-810

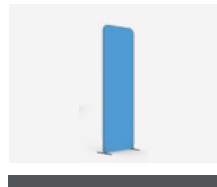

Straight 820
MOD-S-820



Straight 824
MOD-S-824

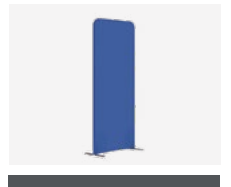

Straight 1020
MOD-S-1020

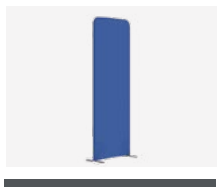

Straight 1024
MOD-S-1024

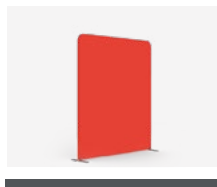

Straight 1820
MOD-S-1820

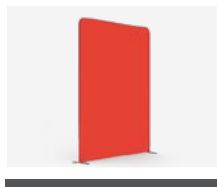

Straight 1824
MOD-S-1824

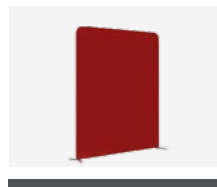

Straight 2020
MOD-S-2020



Straight 2024
MOD-S-2024

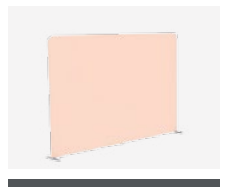

Straight 3020
MOD-S-3020

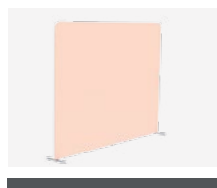

Straight 3024
MOD-S-3024

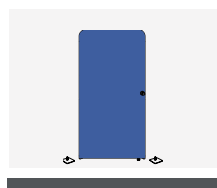

Porta 820
MOD-S-DOOR-820

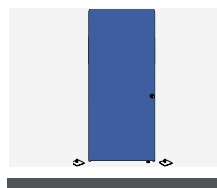

Porta 824
MOD-S-DOOR-824



Curved 820
MOD-C-820



Curved 824
MOD-C-824

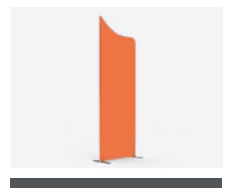

Slope 1
MOD-SS-824-01

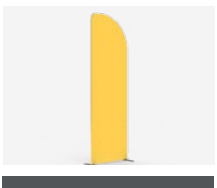

Slope 2
MOD-SS-824-02



DISPONIBILE
ANCHE CON
ANGOLI RETTI

ISTRUZIONI MONTAGGIO